

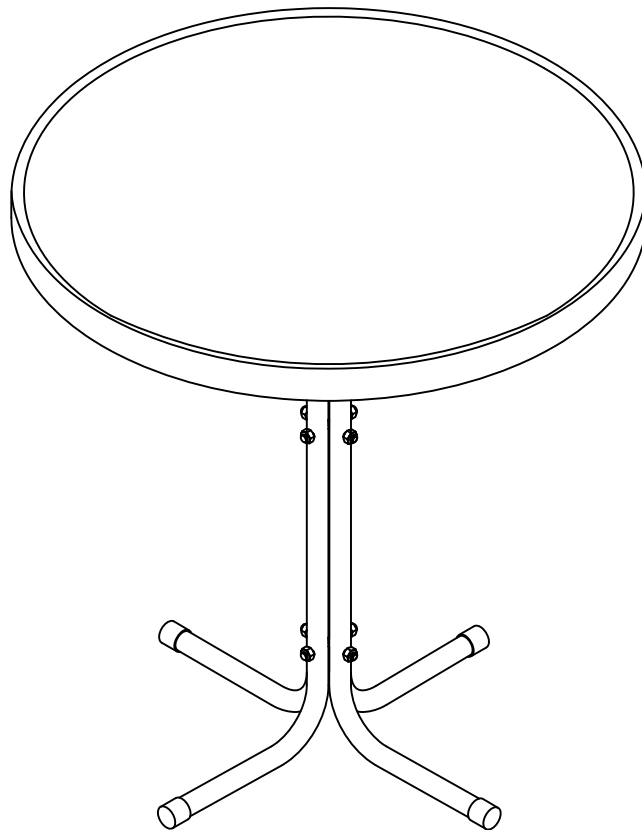





Bistro Table
CO1014

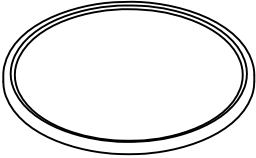

PART LIST

<div data-bbox="81 203 140 264" data-label="Text"> <p>A</p> </div> 	<div data-bbox="375 203 434 264" data-label="Text"> <p>B</p> </div> 
<p>Support Leg 4 PCS</p>	<p>Table Top 1 PC</p>

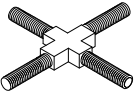
HARDWARE LIST

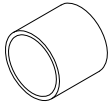
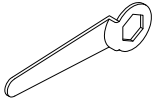
<div data-bbox="65 904 145 965" data-label="Text"> <p>#1</p> </div>  <p>(7.8*80mm)</p>	<div data-bbox="359 904 438 965" data-label="Text"> <p>#2</p> </div> 	<div data-bbox="652 904 732 965" data-label="Text"> <p>#3</p> </div> 	<div data-bbox="946 904 1026 965" data-label="Text"> <p>#4</p> </div> 	<div data-bbox="1240 904 1319 965" data-label="Text"> <p>#5</p> </div> 
<p>"+" Bolt 2 PCS</p>	<p>Nut 8 PCS (Extra 1)</p>	<p>Washer 8 PCS (Extra 1)</p>	<p>Tube Cap 4 PCS</p>	<p>Wrench 4 PCS</p>

IMPORTANT NOTE: WE RECOMMEND AT LEAST TWO PEOPLE WORK TOGETHER TO ASSEMBLE UNIT.

Step 1. Lay table top (part B) upside down on a soft flat surface, such as carpet. Attach one support leg (part A) to another support leg (part A) using "+" bolts (part #1), nuts (part #2) and washers (part #3).

NOTE: Please do not fully tighten bolts until unit is fully assembled.

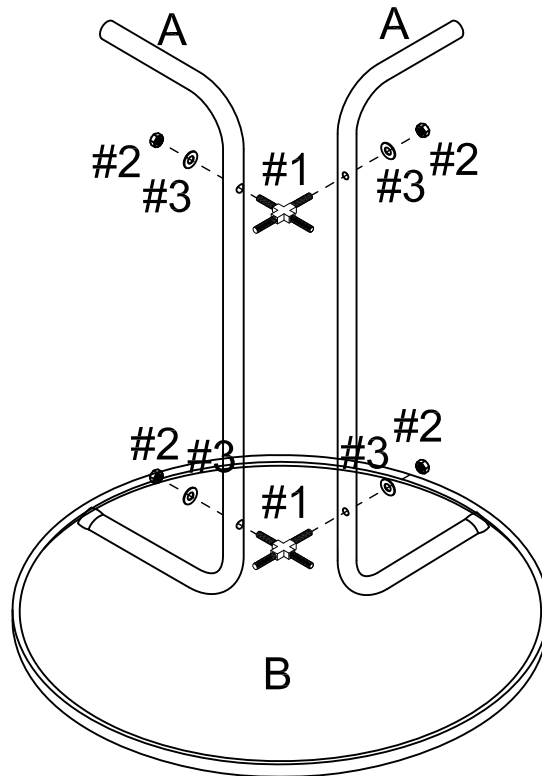

- | | | |
|----|--|-----|
| #1 | | X 2 |
| #2 | | X 4 |
| #3 | | X 4 |

Step 2. Attach remaining support legs (part A) to assembled unit (parts A & B) using nuts (part #2), washers (part #3) and wrench (part #5). Add tube caps (part #4) to support legs (part A).

NOTE: Please full tighten all bolts at this time.

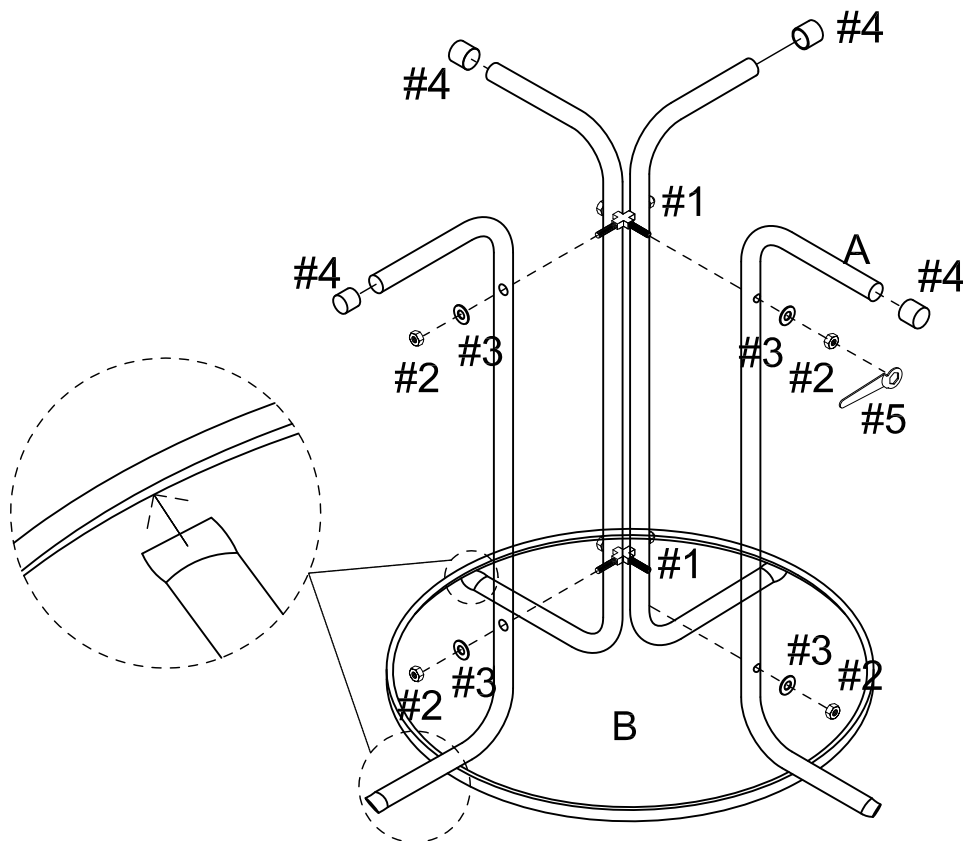

- | | | |
|----|--|-----|
| #2 | | X 4 |
| #3 | | X 4 |
| #4 | | X 4 |
| #5 | | X 1 |

Step 3. Carefully turn assembled unit upright.

